

Movelar®

SUN UMBRELLA STANDS



www.movelar.pt  www.tuozi.pt



SUN UMBRELLA STANDS

MOVELAR & TUOZI

Since 20 years from now, our company develops new solutions for sun-umbrella bases, taking advantage of our concrete production experience since 1979 and the R&D resources, responsible for all MOVELAR products and brands.

Combining a solid experience in concrete production, with injected polypropylene or blown polyethylene, our Research & Development team, created a wide range of solutions for sustaining your umbrella, meeting requirements for both domestic use or the specific HORECA channel.

Innovation and market demand lead us to develop products that better meets its functions and clearly have added value both aesthetic and functionality.



From low weight solutions for water or sand filling, to medium weight bases for the DIY market to concrete high weight and customized solutions for the larger HORECA umbrellas.

High quality finishing with customized possibilities (both on color, surface or branded product), high performance concrete meets design and functionality, resulting in a product that is so much more than a simple weigh to stand your umbrella. It's a base statement, for your outdoor or garden furniture!



0418 | IB00414 ■ GAZEBO

Sun Umbrella Stand | 7L

 0,8 Kg  250 x 320h mm  25 - 32 cmm

SUN UMBRELLA STAND

PE FILL-UP POLYPROPYLENE FOR WATER OR SAND FILL UP

PE FILL-UP - Polypropylene for water or sand fill-up
Universal base Gazebo in white PPP

7 LITER CAPACITY



 Available in:  



0415 ■ PAPILON

Sun Umbrella Stand | 16L

 1 Kg  440 x 120h mm  20 - 32 mm

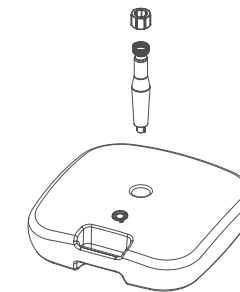

SUN UMBRELLA STAND

PE FILL-UP POLYPROPYLENE FOR WATER OR SAND FILL UP

PE FILL-UP - Polyethylene for water or sand fill-up
Universal base Gazebo in white PPP

16 LITER CAPACITY



 Available in:   
0415 0414 IB00407



0416 ■ TROIA WITH WHEEL
Sun Umbrella Stand | 50L

 1 Kg  480 x 480 x 270h mm  30 - 50 mm

SUN UMBRELLA STAND

PE FILL-UP POLYETHYLENE FOR WATER OR SAND FILL UP

PE FILL-UP - Polyethylene for water or sand fill-up
Sun umbrella stand in white PPP, to fill with water or sand:
50 liters.

50 LITER CAPACITY / WHITE COLOUR



5 606172 004164

Available in: 

www.movelar.pt

IB00018 ■ TROIA WITH WHEEL
Sun Umbrella Stand | 50L

 1 Kg  480 x 480 x 270h mm  30 - 50 mm

SUN UMBRELLA STAND

PE FILL-UP POLYETHYLENE FOR WATER OR SAND FILL UP

Sun umbrella stand in antracite PPP,
to fill with water or sand: 50 liters.

50 LITER CAPACITY / ANTRACITE COLOUR



5 606172 008810

Available in: 

www.movelar.pt

IB00090 ■ CLOVER ANTRACITE

Sun Umbrella Stand | 20L

 1 kg  534 x 534 x 90h

 20 Kg (with water) x 4 = 80kg

 32 Kg (with sand) x 4 = 128kg



TO FILL WITH SAND = 32KG



TO FILL WITH WATER = 20KG

SUITABLE TO USE WITH HANGING PARASOLS WITH 360 ROTATION SYSTEM



BOX DISPLAY=10 UNITS

SUN UMBRELLA STAND

■ PE FILL-UP POLYETHYLENE, FOR WATER OR SAND FILL UP

1/4 blocks in Polyethylene, for water or Sand Fill Up.

Smooth semi mate finishing in anthracite colour.

To use with appropriate metal frame (metal frame not included).

Does not to be painted.



IB00091 CLOVER WHITE



 Available in:  

SENDING IN PACKS OF 4 UNITS (Pallets of 120x120 with 80 units)



5 1606172103036 1

www.movelar.pt



0425 ■ S. JORGE WHITE

Sun Umbrella Stand | 17Kg

 17 Kg  385 x 80h mm  10 - 26 mm

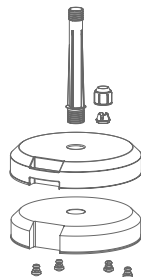

SUN UMBRELLA STAND

■ PP BALLAST POLYPROPYLENE WITH CONCRETE BALLAST



PP BALLAST - Polypropylene with concrete ballast

Concrete with *WHITE* PPP covering

Tube: Ø 10-26 mm

Weight: 17 kg



Available in:  



www.movelar.pt



5 1606172 1004256

0425/2 ■ S. JORGE PLUS WHITE

Sun Umbrella Stand | 18 Kg

 18 Kg  385 x 80h mm  18 - 53 mm

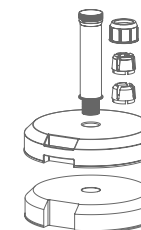

SUN UMBRELLA STAND

■ PP BALLAST POLYPROPYLENE WITH CONCRETE BALLAST

PP BALLAST - Polypropylene with concrete ballast

Concrete with *WHITE* PPP covering

Tube: Ø 18-53 mm

Weight: 18 kg



Available in:    

www.movelar.pt





5 1606172 1042524

www.movelar.pt

0425/3 ■ S. JORGE PLUS ANTRACITE

Sun Umbrella Stand | 18Kg

 18 Kg  385 x 80h mm  18 - 53 mm



IB00384 TAUPE COLOR

SUN UMBRELLA STAND

■ PP BALLAST POLYPROPYLENE WITH CONCRETE BALLAST

PP BALLAST - Polypropylene with concrete ballast
Concrete with ANTRACITE GRAY PPP covering
Tube: Ø 18-53 mm
Weight: 18 kg

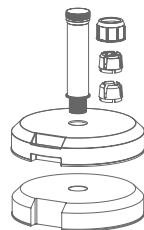

Available in:    
0425/2 IB00001 IB00384 0425/3



0426 ■ S. JORGE WHITE

Sun Umbrella Stand | 22Kg

 22 Kg  430 x 80h mm  10 - 26 mm



SUN UMBRELLA STAND

■ PP BALLAST POLYPROPYLENE WITH CONCRETE BALLAST

PP BALLAST - Polypropylene with concrete ballast
Concrete with WHITE PPP covering
Tube: Ø 10-26 mm
Weight: 22 kg

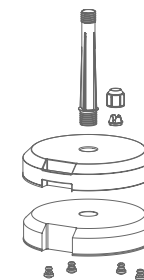

Available in: 



SJORGE

SUN UMBRELLA STAND 21Kg



0426/2 ■ S. JORGE PLUS WHITE

Sun Umbrella Stand | 22 Kg

 22 Kg  430 x 80h mm  18 - 53 mm



IB00452 TAUPE COLOR 

SUN UMBRELLA STAND

PP BALLAST POLYPROPYLENE WITH CONCRETE BALLAST

PP BALLAST - Polypropylene with concrete ballast

Concrete with WHITE PPP covering

Tube: Ø 18-53 mm

Weight: 22 kg

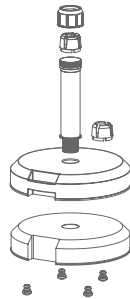

Available in:   
0426/2 IB00452 0426/3



IB00386 ■ S. JORGE TAUPE
Sun Umbrella Stand | 29Kg

 29 Kg  470 x 90h mm  18 - 53 mm



IB00386 TAUPE COLOR

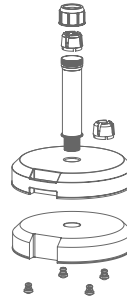

SUN UMBRELLA STAND

■ PP BALLAST POLYPROPYLENE WITH CONCRETE BALLAST

PP BALLAST - Polypropylene with concrete ballast
Concrete with ANTRACITE GRAY PPP covering
Tube: Ø 18-53 mm
Weight: 29 kg



Available in:    
0427 IB00386 0429 IB00428



5 1606172 1073146

0429 ■ S. JORGE ANTRACITE
Sun Umbrella Stand | 29Kg

 29 Kg  470 x 90h mm  18 - 53 mm



IB00386 TAUPE COLOR

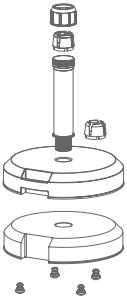

SUN UMBRELLA STAND

■ PP BALLAST POLYPROPYLENE WITH CONCRETE BALLAST

PP BALLAST - Polypropylene with concrete ballast
Concrete with ANTRACITE GRAY PPP covering
Tube: Ø 18-53 mm
Weight: 29 kg

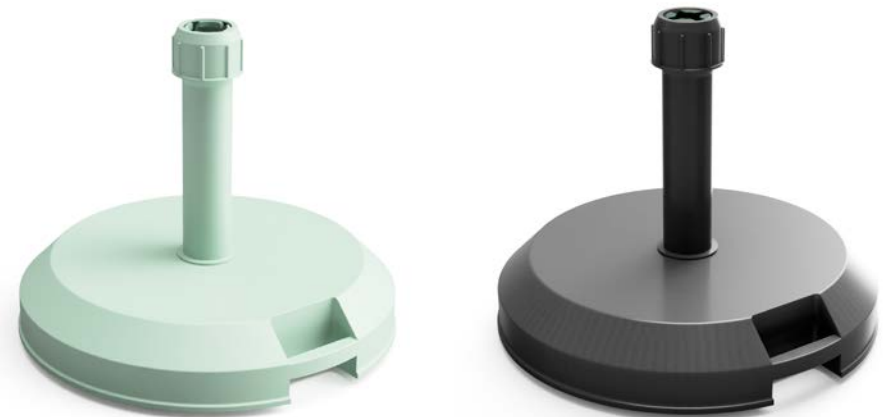

Available in:    
0427 IB00386 0429 IB00428



5 1606172 1004294

0428 ■ ALJUBARROTA WHITE

Sun Umbrella Stand | 39 Kg

39 Kg 540 x 485 x 90h mm 20 - 53 mm

IB00387 TAUPE COLOR

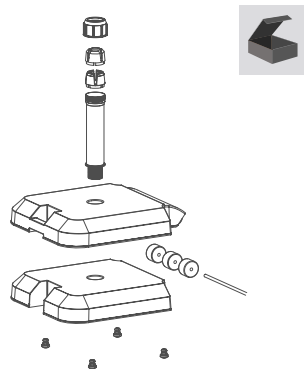

SUN UMBRELLA STAND

PP BALLAST POLYPROPYLENE WITH CONCRETE BALLAST

PP BALLAST - Polypropylene with concrete ballast
Concrete with WHITE PPP covering.
3 Wheel system for easy moving
Weight: 39 kg



Available in:
0428 0428/1 0428/2 IB00387



5 606172 1004287

www.movelar.pt

0428/2 ■ ALJUBARROTA ANTRACITE WITH WHEELS

Sun Umbrella Stand | 39 Kg

39 Kg 540 x 485 x 90h mm 20 - 53 mm

IB00387 TAUPE COLOR

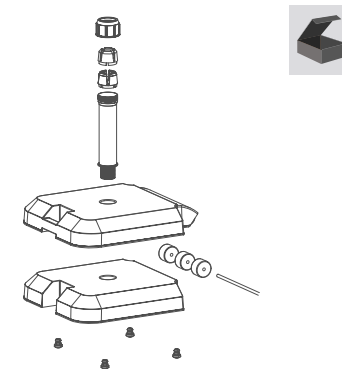

SUN UMBRELLA STAND

PP BALLAST POLYPROPYLENE WITH CONCRETE BALLAST

PP BALLAST - Polypropylene with concrete ballast
Concrete with ANTRACITE GRAY PPP covering.
3 Wheel system for easy moving
Weight: 39 kg



EASY MOVING

Available in:
0428 0428/1 0428/2 IB00387



5 606172 1042821

www.movelar.pt



ALF

SOLUTION FOR **BALCONIES**

HALF PARASOLS

15/20 Kg

IB00280 ■ ALF 20

Sun Umbrella Stand | 20 Kg

 20 Kg  420 x 235 x 90h mm  25-50 mm

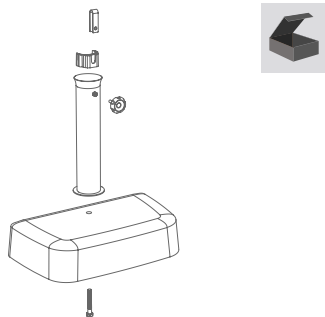

SUN UMBRELLA STAND

■ PRECAST CONCRETE POURED CONCRETE

PRECAST CONCRETE - poured concrete

Varnished Black concrete

Smooth matte finish

Rubber caps for ground protection against scratching

Includes adjustable ring for parasol poles from 25-50 mm

Parasol stand solution for balconies (half parasols)

Weight: 20 Kg



 Available in:



5 606172 1064175 |

T00005 ■ ALF 20

Sun Umbrella Stand | 20 Kg

 20 Kg  420 x 235 x 90h mm  25-50 mm



SUN UMBRELLA STAND

■ PRECAST CONCRETE POURED CONCRETE

PRECAST CONCRETE - poured concrete

Varnished White concrete

Smooth matte finish

Rubber caps for ground protection against scratching

Includes adjustable ring for parasol poles from 25-50 mm

Parasol stand solution for balconies (half parasols)

Weight: 20 Kg



 Available in:



5 606172 1000289 |



SOLUTION FOR BALCONIES

HALF PARASOL

IB00105 / IB00388 ■ ALF 15

Sun Umbrella Stand | 15 Kg

 15 Kg  420 x 235 x 75h mm  18-53 mm

IB00388 TAUPE COLOR

SUN UMBRELLA STAND

■ PRECAST CONCRETE POURED CONCRETE

PRECAST CONCRETE – poured concrete

Varnished grey concrete

Smooth matte finish

Rubber caps for ground protection against scratching

Includes adjustable ring for parasol poles from 18-53 mm

Parasol stand solution for balconies (half parasols)

Weight: 15 Kg

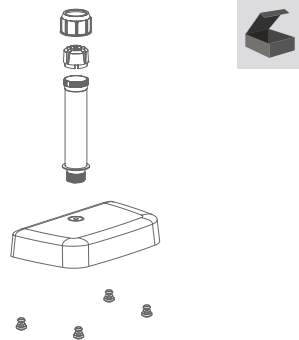

 Available in:  
IB00105 IB00388



www.movekar.pt





DUMBBEL CONCEPT



HALTER

HALTER



DUMBBELL CONCEPT

Smooth mate finishing. Rubber caps for ground protection against scratch. Includes PP adjustment ring, for parasol poles from 25-50 mm / 18-53 mm.

Parasol base, compatible with HALTER 20/30 Weight Plate, allowing to add weight in multiples of approximately 20 kg/30 kg

(dumbbell concept)

20 Kg 30 Kg



HALTER 20/30 [3 WHEEL BASE]

Steel base, black colour, with 3 directional wheels with brake system. Compatible with HALTER 20/30 parasol stands (**Max. 1 base + 2 weight plates**)



HALTER 20/30 [3 WHEEL BASE WITH TUBE]

Steel base, black colour, with 3 directional wheels with brake system. Compatible with HALTER 20/30 Weight Plates (**max. 3 units**)

HALTER WITH WHEELS

DUMBBELL CONCEPT

Smooth mate finishing. Rubber caps for ground protection against scratch. Includes PP adjustment ring, for parasol poles from 25-50 mm / 18-53 mm.

Parasol base, compatible with HALTER 20/30 Weight Plate, allowing to add weight in multiples of approximately 20 kg/30 kg

(dumbbell concept)



 30 Kg

tuozì
by Movelar®



IB00041 ■ HALTER 20 PLUS (GRAY)

Sun Umbrella Stand | 20Kg **DUMBBELL CONCEPT**

 20 Kg  446 x 60h mm  18-53mm



SUN UMBRELLA STAND

■ PRECAST CONCRETE POURED CONCRETE

POURED CONCRETE - GRAY concrete

Smooth mate finishing.

Rubber caps for ground protection against scratch.

Includes PP adjustment ring, for parasol poles from 18-53mm.

Parasol base, compatible with HALTER 20 Weigh Plate, allowing to add weight in multiples of approximately 20 kg, (*dumbbell concept*)



[IB00040]





[IB00042]



IB00044 ■ HALTER 30 PLUS

Sun Umbrella Stand | 30Kg **DUMBBELL CONCEPT**

 30 Kg  541 x 60h mm  18-53 mm



SUN UMBRELLA STAND

■ PRECAST CONCRETE POURED CONCRETE

POURED CONCRETE - GRAY concrete

Smooth mate finishing.

Rubber caps for ground protection against scratch.

Includes PP adjustment ring, for parasol poles from 18-53mm.

Parasol base, compatible with HALTER 30 Weigh Plate,

allowing to add weight in multiples of approximately 30 kg,

(*dumbbell concept*)



[IB00043]



[IB00391]



[IB00045]



TAUPE COLOR



IB00391 HALTER 30 PLUS

TAUPE CONCRETE
Sun Umbrella Stand | 30Kg



IB00393 HALTER 30 PLUS

TEXTURED GRAY CONCRETE
Sun Umbrella Stand | 30Kg



IB00455 HALTER 30 PLUS

TEXTURED GRAY CONCRETE 30 KG

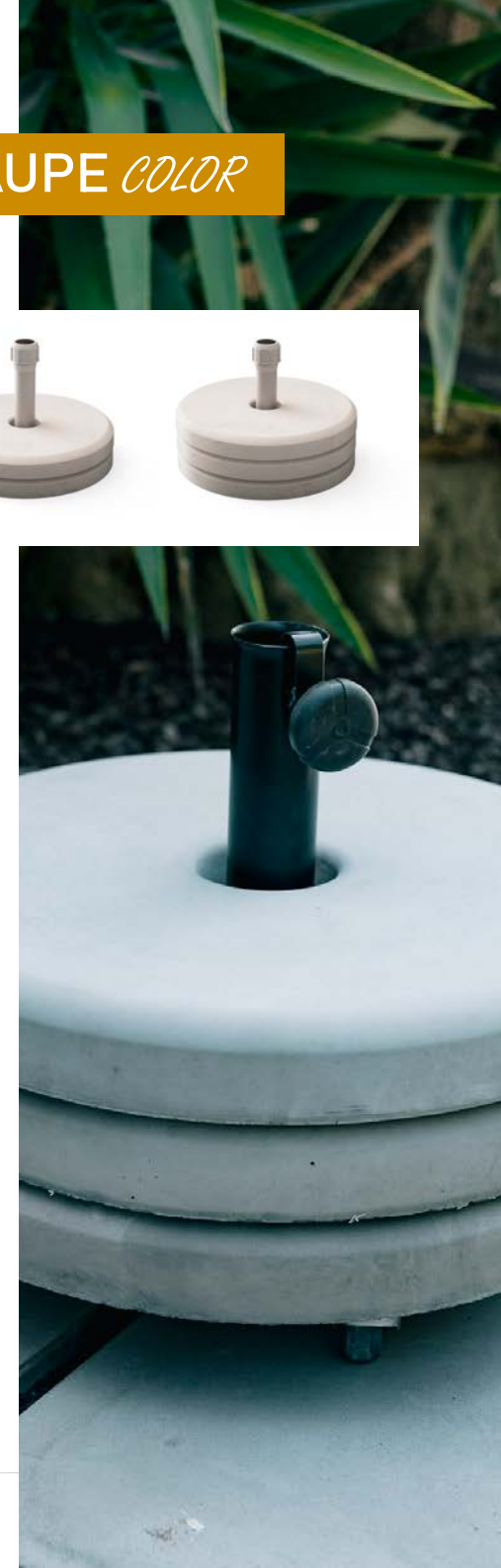

IB00059 ■ HALTER 30 PLUS WITH WHEELS

Sun Umbrella Stand | 30Kg **DUMBBELL CONCEPT**

30 Kg 541 x 120h mm 25-50 mm



SUN UMBRELLA STAND

■ PRECAST CONCRETE POURED CONCRETE

POURED CONCRETE - GRAY concrete

Smooth mate finishing.

Rubber caps for ground protection against scratch.

Includes PP adjustment ring, for parasol poles from 18-53mm.

Parasol base, compatible with HALTER 30 Weigh Plate, allowing to add weight in multiples of approximately 30 kg, (dumbbell concept)

Available in:

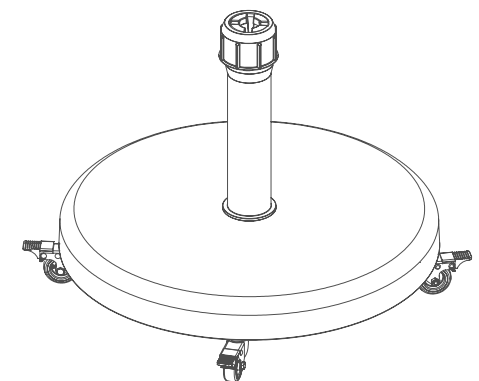

HALTER 30 WITH WHEELS

- GRAY CONCRETE **IB00059**
- WHITE CONCRETE **IB00057**
- GRANITE CONCRETE **IB00061**

HALTER 20 WITH WHEELS

- GRAY CONCRETE **IB00058**
- WHITE CONCRETE **IB00056**
- GRANITE CONCRETE **IB00060**

METAL FRAME WITH WHEELS

IB00033 ■ HALTER 20 [3 WHEEL BASE]

↻ 682 x 72h mm ⚖ 5 Kg ↻

IB00034 ■ HALTER 30 [3 WHEEL BASE]

↻ 777 x 72h mm ⚖ 6,5 Kg ↻



HALTER 20/30 [3 WHEEL BASE]

Steel base, black colour, with 3 directional wheels with brake system. Compatible with HALTER 20/30 parasol stands (Max. 1 base + 2 weight plates)



IB00035 ■ HALTER 20 [3 WHEEL BASE + TUBE]

↻ 682 x 72h mm | 25-50 mm ⚖ 5,9 Kg ↻

IB00036 ■ HALTER 30 [3 WHEEL BASE + TUBE]

↻ 777 x 72h mm | 25-50 mm ⚖ 7,4 Kg ↻



HALTER 20/30 [3 WHEEL BASE WITH TUBE]

Steel base, black colour, with 3 directional wheels with brake system. Compatible with HALTER 20/30 parasol stands (Max. 3 units)



IB00096 ■ HALTER 30 PLUS

Sun Umbrella Stand | 30Kg **DUMBBELL CONCEPT**

⚖ 30 Kg ↻ 541 x 60h mm | Metal Tube 60 > 25-50 mm



IB00064 30 kg > Metal Tube 70 > 40-60 mm

Available in: ↻



SUN UMBRELLA STAND

■ PRECAST CONCRETE POURED CONCRETE

POURED CONCRETE - GRAY concrete

Smooth mate finishing.

Rubber caps for ground protection against scratch.

Includes PP adjustment ring, for parasol poles from 25-50mm.

Parasol base, compatible with HALTER 30 Weigh Plate, allowing to add weight in multiples of approximately 30 kg, (dumbbell concept)

METAL TUBE 60 (30 KG)

GRAY CONCRETE IB00096

WHITE CONCRETE IB00098

GRANITE CONCRETE IB00097

METAL TUBE 70 (30 KG)

GRAY CONCRETE IB00064

WHITE CONCRETE IB00066

GRANITE CONCRETE IB00065



5 1606172 1030446

IB00093 ■ HALTER 30 PLUS WITH WHEELS
Sun Umbrella Stand | 30Kg **DUMBBELL CONCEPT**

30 Kg 541 x 120h mm Metal Tube 60 > 25-50 mm

IB00069 30 kg > Metal Tube 70 > **40-60** mm

SUN UMBRELLA STAND

■ **PRECAST CONCRETE** POURED CONCRETE

POURED CONCRETE - GRAY concrete

Smooth mate finishing.

Rubber caps for ground protection against scratch.

Includes PP adjustment ring, for parasol poles from 25-50 / 40-60 mm.

Parasol base, compatible with HALTER 30 Weigh Plate, allowing to add weight in multiples of approximately 30 kg, (dumbbell concept)

METAL TUBE 60 (30 KG)

GRAY CONCRETE **IB00093**

WHITE CONCRETE **IB00094**

GRANITE CONCRETE **IB00095**

METAL TUBE 70 (30 KG)

GRAY CONCRETE **IB00069**

WHITE CONCRETE **IB00071**

GRANITE CONCRETE **IB00070**

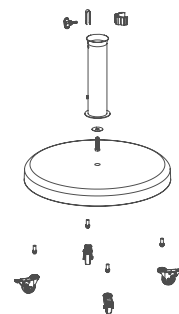

HALTER WITH WHEELS

DUMBBELL CONCEPT

Smooth mate finishing. Rubber caps for ground protection against scratch. Includes PP adjustment ring, for parasol poles from 25-50 mm / 40-60 mm. Parasol base, compatible with HALTER 30 Weight Plate, allowing to add weight in multiples of approximately 30 kg

(dumbbell concept)

20 Kg 30 Kg



METAL TUBE 60 (20 KG)

GRAY CONCRETE IB00099

WHITE CONCRETE IB00101

GRANITE CONCRETE IB00100

METAL TUBE 70 (20 KG)

GRAY CONCRETE IB00072

WHITE CONCRETE IB00074

GRANITE CONCRETE IB00073

METAL TUBE 60 (30 KG)

GRAY CONCRETE IB00096

WHITE CONCRETE IB00098

GRANITE CONCRETE IB00097

METAL TUBE 70 (30 KG)

GRAY CONCRETE IB00064

WHITE CONCRETE IB00066

GRANITE CONCRETE IB00065



COLOURS



30



60



93

WITH WHEELS

METAL TUBE 60 (20 KG)

GRAY CONCRETE IB00075

WHITE CONCRETE IB00077

GRANITE CONCRETE IB00076

METAL TUBE 70 (20 KG)

GRAY CONCRETE IB00102

WHITE CONCRETE IB00104

GRANITE CONCRETE IB00103

METAL TUBE 60 (30 KG)

GRAY CONCRETE IB00093

WHITE CONCRETE IB00094

GRANITE CONCRETE IB00095

METAL TUBE 70 (30 KG)

GRAY CONCRETE IB00069

WHITE CONCRETE IB00071

GRANITE CONCRETE IB00070

IB00004 ■ OCTA 37

Sun Umbrella Stand | 37 Kg

 37 Kg  520 x 100h mm  18-35 mm

SUN UMBRELLA STAND

■ PRECAST CONCRETE POURED CONCRETE

POURED CONCRETE - GRAY concrete

Octagonal shape, washed concrete (textured)

Rubber caps for ground protection against scratching

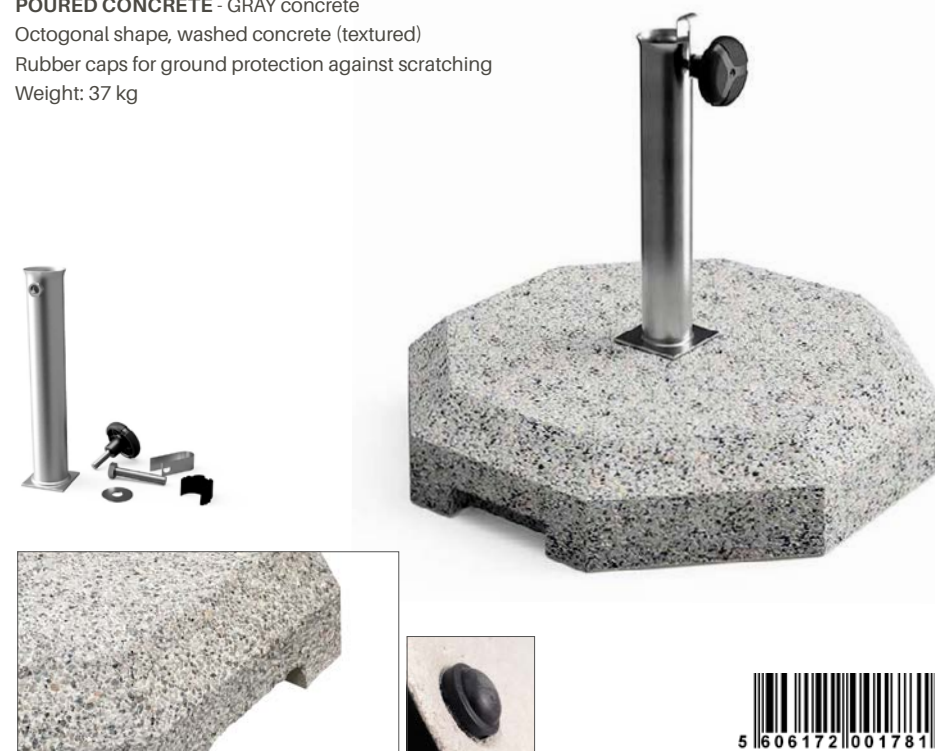

Weight: 37 kg



5 1606172 1001781

www.movelar.pt

0466 ■ AGO 40 (SLIM EDGE) WASHED CONCRETE
Sun Umbrella Stand | 37 kg

 37Kg  600 x 80h mm  Ø 25-50 mm 

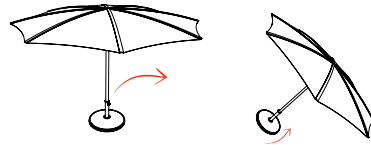

SUN UMBRELLA STAND

■ PRECAST CONCRETE POURED CONCRETE

Parasol stand in WASHED concrete plain matte finish.
Parasol stand that can be moved with the umbrella fitted on, just by rolling both elements using the concrete stand as a wheel.
Stand's edge reinforced with an aluminized steel rim.
Rubber caps for ground protection against scratching

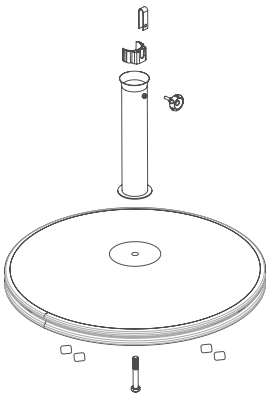

 37Kg  47Kg



Available in: 

www.movelar.pt

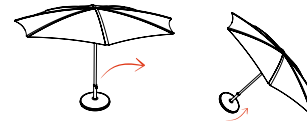

AGO

Slim Edge 40 Kg

can be moved with the umbrella fitted...



0465 ■ AGO 40 (SLIM EDGE) WHITE
Sun Umbrella Stand | 37kg

37Kg 600 x 80h mm Ø 25-50 mm

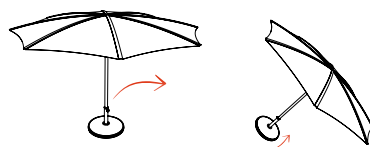
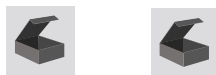

SUN UMBRELLA STAND

■ PRECAST CONCRETE POURED CONCRETE

Parasol stand in WHITE concrete plain matte finish.
Parasol stand that can be moved with the umbrella fitted on, just by rolling both elements using the concrete stand as a wheel.
Stand's edge reinforced with an aluminized steel rim.
Rubber caps for ground protection against scratching



37Kg 47Kg



Available in:

0467 ■ AGO 40 (SLIM EDGE) GRAY
Sun Umbrella Stand | 37 kg

37Kg 600 x 80h mm Ø 25-50 mm

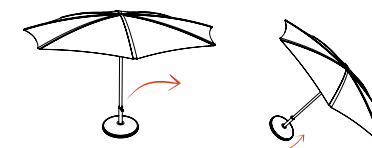

SUN UMBRELLA STAND

■ PRECAST CONCRETE POURED CONCRETE

Parasol stand in NATURAL GRAY concrete plain matte finish.
Parasol stand that can be moved with the umbrella fitted on, just by rolling both elements using the concrete stand as a wheel.
Stand's edge reinforced with an aluminized steel rim.
Rubber caps for ground protection against scratching



37Kg 47Kg



Available in:

0460 ■ SPECTRAL 40 CONCRETE
Sun Umbrella Stand | 46 kg



46 Kg



595 x 90h cm



Ø 25-50 mm

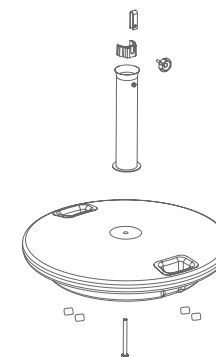

SUN UMBRELLA STAND

■ PRECAST CONCRETE POURED CONCRETE

Parasol stand in GRAY concrete
Rubber caps for ground protection against scratching
2 handles embedded on the concrete

Concrete parasol stand that allows to be customized with a pp coloured cover to match with your garden furniture or sun umbrella.

6 available colours (covers are sold separately)

Weight : 46 Kg



0461 SPECTRAL CONCRETE 50

57 Kg



Available in:



46Kg 57Kg



5 606172 1004607



SPECTRAL

TO BE CUSTOMIZED WITH A PP COLOUR COVER

0462/7 ■ SPECTRAL 40 CONCRETE
Sun Umbrella Stand | 46 kg

37Kg 595 x 90h cm Ø 25-50 mm



0463/7 SPECTRAL CONCRETE 50 57 Kg

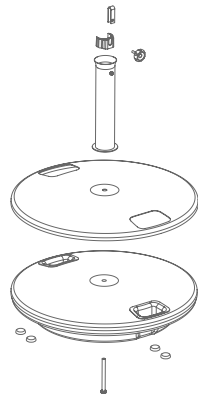

SUN UMBRELLA STAND

■ PRECAST CONCRETE POURED CONCRETE

Parasol stand in GRAY concrete

Rubber caps for ground protection against scratching

2 handles embedded on the concrete

Concrete parasol stand that allows to be customized with a pp coloured cover to match with your garden furniture or sun umbrella.

6 available colours (covers are sold separately)

Weight: 40 Kg



Available in:



www.movelar.pt



DRESS YOUR SUN UMBRELLA STAND

to match with your garden furniture or sun umbrella!



37 & 47 Kg



0462/6 SPECTRAL 40
0463/6 SPECTRAL 50



0462/7 SPECTRAL 40
0463/7 SPECTRAL 50



0462/2 SPECTRAL 40
0463/2 SPECTRAL 50



0462/1 SPECTRAL 40
0463/1 SPECTRAL 50



0462/5 SPECTRAL 40
0463/5 SPECTRAL 50



0462/4 SPECTRAL 40
0463/4 SPECTRAL 50



0462/3 SPECTRAL 40
0463/3 SPECTRAL 50

* Other colors available upon request (minimum quantity for other colors: 1000 units).

www.movelar.pt

0442 ■ STEALTH 50

Sun Umbrella Stand | 50 kg

 50 Kg  570 x 570 x 70h mm  25-50 mm

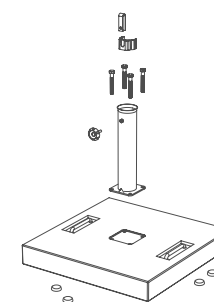

SUN UMBRELLA STAND

■ PRECAST CONCRETE POURED CONCRETE

POURED CONCRETE - Varnished dark gray concrete (anthracite)

Smooth mate finish

Rubber caps for ground protection against scratching and 2 metal handles

Weight: 50 Kg



[0444]



[0448]



Available in:   



www.movelar.pt

0443 ■ STEALTH 50 ROLL

Sun Umbrella Stand | 50 Kg

50 Kg 570 x 570 x 70h mm 25-50 mm

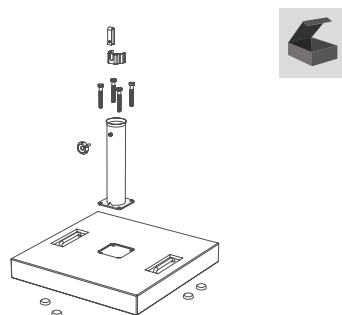

SUN UMBRELLA STAND

PRECAST CONCRETE POURED CONCRETE

POURED CONCRETE - Varnished dark gray concrete (anthracite)

Smooth mate finish

Rubber caps for ground protection against scratching and 2 metal handles

2 wheels for easy displacement

Weight: 50 Kg



Available in:



IB00053 ■ STEALTH 4 WHEELS

Sun Umbrella Stand | 50 kg

50 Kg 570 x 570 x 140h mm 25-50 mm



SUN UMBRELLA STAND

PRECAST CONCRETE POURED CONCRETE

POURED CONCRETE - Varnished dark gray concrete (anthracite)

Smooth mate finish

2 metal handles and **4 wheels for easy displacement**

Weight: 50 Kg



Available in:



IB00357 ■ STEALTH 50 ROLL *INOX 316*

Sun Umbrella Stand | 50 Kg

 50 Kg  570 x 570 x 70h mm  25-50 mm



SUN UMBRELLA STAND

■ PRECAST CONCRETE POURED CONCRETE

POURED CONCRETE - Varnished dark gray concrete (anthracite)

Smooth mate finish

316 StainlessSteel Tube. Rubber caps for ground protection against scratching

and 2 316 StainlessSteel metal handles .

2 wheels for easy displacement

Weight: 50 Kg



[IB00352]

[IB00361]

 Available in: 



5 160617210580201

IB00394 ■ STEALTH 50 4 WHEELS

Sun Umbrella Stand | 50 Kg

 50 Kg  570 x 570 x 70h mm  25-50 mm



SUN UMBRELLA STAND

■ PRECAST CONCRETE POURED CONCRETE

POURED CONCRETE - Varnished dark gray textured concrete (anthracite)

Rubber caps for ground protection against scratching and 2 metal handles

2 wheels for easy displacement

Weight: 50 Kg



 Available in: 



DESIGNED
TO ADAPT
BUILT TO **STAND OUT**

LUNARIS

DESIGNED & MANUFACTURED IN EU-PORTUGAL by MOVELAR

POLYPROPYLENE
WITH CONCRETE BALLAST

4W
360° 4 CASTOR WHEELS

ROLL
WITH WHEELS

INTEGRATED HANDLE
FOR EASY MOVEMENT



IB00492 ■ LUNARIS

Sun Umbrella Stand | 50 Kg

 50 Kg  550 x 550 x 105h mm  25-50 mm

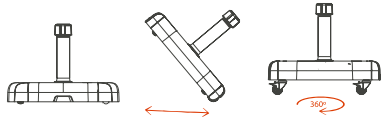

SUN UMBRELLA STAND

■ PP BALLAST - POURED CONCRETE

PP BALLAST - Polypropylene with concrete ballast
Concrete with PPP covering
Weight: 50 Kg



[IB00493]



[IB00494]



 Available in: 



5 606172 085491

IB00495 ■ LUNARIS

Sun Umbrella Stand | 50 Kg

 50 Kg  550 x 550 x 105h mm  25-50 mm

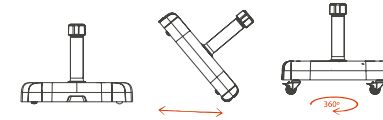

SUN UMBRELLA STAND

■ PP BALLAST - POURED CONCRETE

PP BALLAST - Polypropylene with concrete ballast
Concrete with PPP covering
Weight: 50 Kg



[IB00496]



[IB00497]



 Available in: 



5 606172 085521

LUNARIS

DESIGNED & MANUFACTURED IN EU-PORTUGAL by MOVELAR

ANTHRACITE

WHITE

TAUPE

NATO GREEN

BROWN

AVAILABLE
IN 5 COLOURS

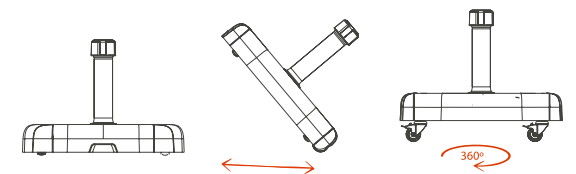

IB00008 ■ MISTRAL (Black)

Sun Umbrella Stand | 55 kg

 55 Kg

 585 x 585 x 100h mm

 25-50mm

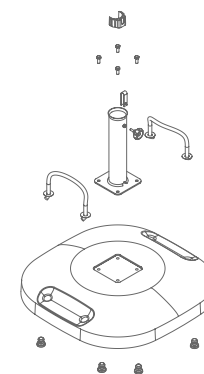

SUN UMBRELLA STAND

■ PRECAST CONCRETE POURED CONCRETE

POURED CONCRETE - Varnished dark gray concrete (anthracite)

Smooth mate finish

Rubber caps for ground protection against scratching and 2 metal handles

Weight: 50 Kg

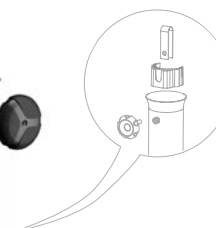

[IB00009]



 Available in:  



IB00188 ■ MISTRAL ROLL

Sun Umbrella Stand | 55 kg

 55 Kg

 585 x 585 x 170h mm

 25-50 mm

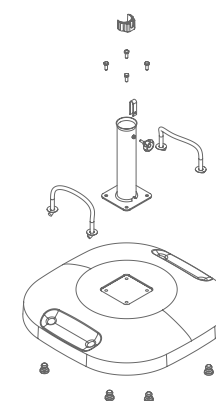

SUN UMBRELLA STAND

■ **PRECAST CONCRETE** POURED CONCRETE

POURED CONCRETE - Varnished black concrete.

Smooth mate finishing.

4 directional wheels with brake.

2 rope handles for easy displacement.



[IB00027]



[IB00028]



 Available in: 



IB00381 ■ MILOS 55 (gray)
Sun Umbrella Stand | 45 Kg

 45 Kg  600 x 80h mm  25-50 mm



SUN UMBRELLA STAND

■ PRECAST CONCRETE POURED CONCRETE

Washed concrete (textured)
Rubber caps for ground protection against scratching
Sisal and rubber handles for easy moving
Weight: 45 kg





[IB00002]

[IB00052]



5 606172 072880

IB00106 ■ INUMBRA 55 ROLL (gray)
Sun Umbrella Stand | 45 Kg

 45 Kg  600 x 80h mm  25-50 mm



SUN UMBRELLA STAND

■ PRECAST CONCRETE POURED CONCRETE



Washed concrete (textured)
4 directional wheels with brake.
2 rope handles for easy displacement.
Weight: 45 kg



5 606172 103083 5

IB00052 ■ INUMBRA 55 ROLL

Sun Umbrella Stand | 45 Kg

 45 Kg  600 x 80h mm  25-50 mm



SUN UMBRELLA STAND

■ PRECAST CONCRETE POURED CONCRETE

Washed concrete
4 directional wheels with brake.
2 rope handles for easy displacement.
Weight: 45 kg



5 606172 022717

0438 / IB00005 ■ KIRA 55

Sun Umbrella Stand | 55 kg

 55 Kg  500 x 500 x 100h  25-50 mm



SUN UMBRELLA STAND

■ PRECAST CONCRETE POURED CONCRETE

Washed white concrete
Textured finish
Rubber caps for ground protection against scratching
2 metal handles
Weight: 55 Kg





5 606172 001798

 Available in:  

0440 ■ MOVELAR 017

Sun Umbrella Stand | 55 kg

 55 Kg  500 x 500 x 170h mm  25-50 mm

SUN UMBRELLA STAND

■ PRECAST CONCRETE POURED CONCRETE

Washed concrete (textured)

2 metal handles and 4 directional wheels with braking system

Weight: 55 kg



[0441]

Available in:  



5 606172 004409

IB00003 ■ MILOS 94

Sun Umbrella Stand | 94 Kg

 94 Kg  710 x 120h mm  40-60mm

SUN UMBRELLA STAND

■ PRECAST CONCRETE POURED CONCRETE

PRECAST CONCRETE - Poured concrete

Washed concrete (textured)

Rubber caps for ground protection against scratching

Sisal and rubber handles for easy moving

Weight: 94 kg

Doesn't need to be painted.



5 606172 001774

IB00030 ■ MOVELAR 012 GRAY ROLL
Sun Umbrella Stand | 96Kg

 96 Kg  800 x 170h mm  40-60 mm

SUN UMBRELLA STAND

■ PRECAST CONCRETE POURED CONCRETE



PRECAST CONCRETE - Poured concrete
Washed concrete
4 directional wheels with brake system.
Doesn't need to be painted.



 Available in:  



IB00029 ■ BALOS 96 ROLL
Sun Umbrella Stand | 96Kg

 96 Kg  800 x 170h mm  40-60 mm

SUN UMBRELLA STAND

■ PRECAST CONCRETE POURED CONCRETE

PRECAST CONCRETE - Poured concrete
Washed concrete (textured).
4 directional wheels with brake system.
Doesn't need to be painted.



 Available in: 





MOVELAR 012 ROLL

4 DIRECTIONAL WHEELS WITH BRAKE SYSTEM

IB00030 96 kg

0407 ■ BALOS 96

Sun Umbrella Stand | 96Kg

 96 Kg  800 x 100h mm  40-60 mm

4 DIRECTIONAL WHEELS

WITH BRAKE 96 Kg

SUN UMBRELLA STAND

■ PRECAST CONCRETE POURED CONCRETE

Washed concrete (textured)

Rubber caps for ground protection against scratching

Weight: 96 kg



[1800470]



 Available in: 



www.movelar.pt

IB00127 ■ SCALA GRAY ROLL
Sun Umbrella Stand | 96Kg



96 Kg 800 x 170h mm

SUN UMBRELLA STAND

■ PRECAST CONCRETE POURED CONCRETE

- PRECAST CONCRETE - Poured concrete
- Washed concrete
- 4 directional wheels with brake system
- Diagonal between 133 and 172mm (min - máx)
- Sisal and rubber handles for easy moving
- Doesn't need to be painted.



Available in:



5 1606172 1053995

IB00126 ■ SCALA GRAY ROLL
Sun Umbrella Stand | 96Kg



96 Kg 800 x 170h mm

SUN UMBRELLA STAND

■ PRECAST CONCRETE POURED CONCRETE

- PRECAST CONCRETE - Poured concrete
- Washed concrete
- 4 directional wheels with brake system
- Diagonal between 133 and 172mm (min - máx)
- Doesn't need to be painted.



Available in:



5 1606172 1053995

INUMBRA 012 GRAYROLL

4 DIRECTIONAL WHEELS WITH BRAKE SYSTEM



IB00006 ■ KAMARI 130

Sun Umbrella Stand | 130 Kg

 130 Kg  750 x 750 x 120h mm  109-110 mm

SUN UMBRELLA STAND

■ PRECAST CONCRETE POURED CONCRETE

PRECAST CONCRETE - Poured concrete

Washed concrete

Rubber caps for ground protection against scratching

2 metal handles

Pole diameter up to 100mm.

Doesn't need to be painted.



sunny living 



130Kg



0451/2 ■ LESS 17

Sun Umbrella Stand | 17 Kg



17 Kg



580 x 580 x 30h mm



25-50 mm



SUN UMBRELLA STAND

■ STEEL ALLOY STEEL

Black/white or grey coated 5mm steel base, with low gravity center (very stable)

Base main surface, slightly elevated from the floor for water drainage

Equipped with tube for fitting poles from 25-50 mm diameter.



[0451/3]



[0451]



Available in:



5 1606172 1004515

www.movelar.pt

IB00132 ■ LESS 17 CORTEN PAINTING

Sun Umbrella Stand | 17 Kg

 17 Kg  580 x 580 x 30h mm  25-50 mm



SUN UMBRELLA STAND

STEEL ALLOY STEEL

Corten painting coated 5mm steel base, with low gravity center (very stable)
 Base main surface, slightly elevated from the floor for water drainage
 Equiped with tube for fitting poles from 25-50 mm diameter.



CORTEN PAINTING

 Available in:    



IB00197 ■ CELL 16

Sun Umbrella Stand | 16 Kg

 16 Kg  593 x 593 x 60h mm  25-50 mm







 16  26  39

SUN UMBRELLA STAND

STEEL ALLOY STEEL

White coated 5mm steel base, with low gravity center (very stable)
 Base main surface, slightly elevated from the floor for water drainage
 Equiped with tube for fitting poles from 25-50 mm diameter.



 Available in:   



T00300 ■ BISC 16 LIGHT GRAY
Sun Umbrella Stand | 15kg

 15 Kg/piece  485 x 485 x 45h mm

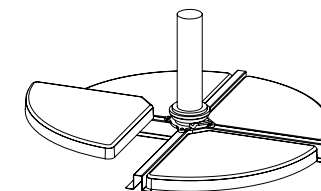

SUN UMBRELLA STAND

■ PRECAST CONCRETE POURED CONCRETE

PRECAST CONCRETE - Poured concrete
1/4 blocks in textured pressed concrete Model BISC.
To use with appropriate metal frame
(metal frame not included).
Weights aproximatly 16 kg/piece.



- Multiple configurations possibly:**
- 2 pieces weights aproximatly 32Kg
 - 4 pieces weights aproximatly 64Kg
 - 6 pieces weights aproximatly 96Kg
 - 8 pieces weights aproximatly 128Kg

Doesn't need to be painted

*Parasol dimentionis:
4 pieces (64 kg) up to 3x3 meters*



 Available in:  



LATERAL POLE

SUN UMBRELLA STANDS

IB00079 ■ BISC PLUS 16 BLACK
Sun Umbrella Stand | 16 kg

 16 Kg/piece  485 x 485 x 45h mm

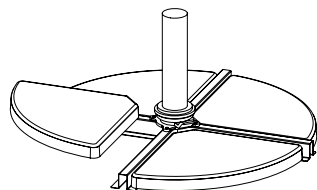

SUN UMBRELLA STAND

■ PRECAST CONCRETE POURED CONCRETE

PRECAST CONCRETE - Poured concrete
1/4 blocks in textured pressed concrete Model BISC.
Textured finish, with black matte varnish
To use with appropriate metal frame
(metal frame not included).
Weight: 16kg/piece.

Multiple configurations possibly:
- 2 pieces weights aproximatly 32Kg
- 4 pieces weights aproximatly 64Kg
- 6 pieces weights aproximatly 96Kg
- 8 pieces weights aproximatly 128Kg

Doesn't need to be painted

*Parasol dimentionis:
4 pieces (64 kg) up to 3x3 meters*



5 1606172 10000811

 Available in:  

0408/3 ■ GOMO 25 ECO LIGHT GREY (1/4)
Sun Umbrella Stand | 26 Kg

IB00269 ■ GOMO 25 ECO RAW
Sun Umbrella Stand | 26 Kg

 25 Kg/piece  475 x 475 x 60h mm

SUN UMBRELLA STAND

■ PRECAST CONCRETE POURED CONCRETE

PRECAST CONCRETE - Poured concrete
1/4 blocks in textured finishing
Natural concrete grey color
To use with appropriate metal frame
(metal frame not included)
Weight: 25 kg



5 1606172 10408341 5 606172 064816

 Available in:  

IB00107 ■ GOMO 26 ECO GRANITE LOOK (1/4)
Sun Umbrella Stand | 25 Kg

 25 Kg/piece  475 x 475 x 60h mm

SUN UMBRELLA STAND

■ PRECAST CONCRETE POURED CONCRETE

PRECAST CONCRETE - Poured concrete
1/4 blocks in textured concrete
Granite Look
To use with appropriate metal frame
(metal frame not included)
Weight: 25 kg



IB00108 ■ GOMO 26 ECO GREY VARNISH (1/4)
Sun Umbrella Stand | 25 Kg

 25 Kg/piece  475 x 475 x 60h mm



SUN UMBRELLA STAND

■ PRECAST CONCRETE POURED CONCRETE

PRECAST CONCRETE - Poured concrete
1/4 blocks in poured concrete with grey varnish
To use with appropriate metal frame
(metal frame not included)
Weight: 25 kg



T00001 ■ GOMO 26 ECO PLUS BLACK (1/4)
Sun Umbrella Stand | 25 Kg

 25 Kg/piece  475 x 475 x 60h mm

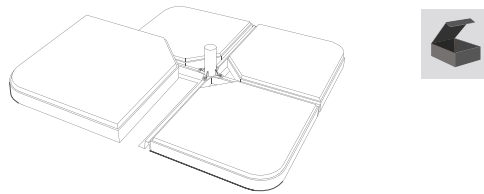

SUN UMBRELLA STAND

■ PRECAST CONCRETE POURED CONCRETE

PRECAST CONCRETE - Poured concrete
1/4 blocks in texture finishing, with black mate

Product provided with box

To use with appropriate metal frame
(metal frame not included)

Weight: 25 kg



0408 ■ GOMO 26 BLACK (1/4)
Sun Umbrella Stand | 26 kg

 26 Kg/piece  475 x 475 x 60h mm

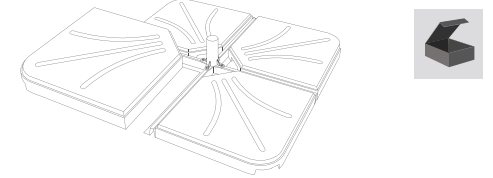

IB00031 TAUPE COLOR

SUN UMBRELLA STAND

■ PRECAST CONCRETE POURED CONCRETE

PRECAST CONCRETE - Poured concrete
1/4 blocks in textured pressed concrete (Model Bisc)

Textured finish

To use with appropriate metal frame
(metal frame not included)

Weights 25Kg



IB00031



0408/1



0408



0408/2



 Available in:   



IB00032 ■ METAL FRAME

Structure for Blocks

 9 Kg

 1000 x 1000 x 136,5h mm

BASE FRAME

■ STEEL ALLOY STEEL

Metal frame with wheels for
ECCENTRIC Sun Umbrella Stand
 Compatible with multiple LATERAL POLE
 sun umbrella stands
 Alloy steel

Compatible with the following GOMO models:
 References: 0408 / 0408/1 / 0408/2 / 0408/3 /
 IB00107 / T00001 / IB00108



NOTE: CHECK COMPATIBILITY WITH YOUR SUN UMBRELLA



5 1606172 022465

www.movelar.pt



PRECAST CONCRETE



PEBBLE 25 [360]

IB00015 BLOCKS IN POLYPROPYLENE FILLED WITH CONCRETE

IB00015 ■ PEBBLE 25 [360] ANTHRACITE (1/4)
Sun Umbrella Stand | **25 kg**

 25 Kg/piece  540 x 540 x 90h mm

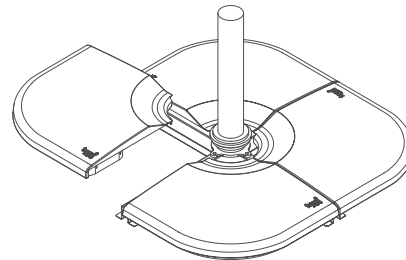

SUN UMBRELLA STAND

■ **PRECAST CONCRETE** POURED CONCRETE WITH PPOLYETHYLENE

- PP BALLAST - Polyethylene with concrete ballast
- _ 1/4 blocks in Polyethylene filled with concrete
 - _ Smooth semi matte finish
 - _ Felt caps for ground protection against scratching
 - _ To use with appropriate metal frame (metal frame not included)
 - _ Weight: **25Kg** or **35Kg**

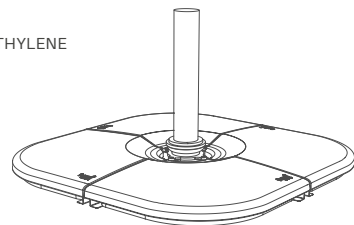

 Available in: 



5 606172 007110

IB00016 ■ PEBBLE 25 [360] WHITE (1/4)
Sun Umbrella Stand | **25 kg**

 25 Kg/piece  540 x 540 x 90h mm

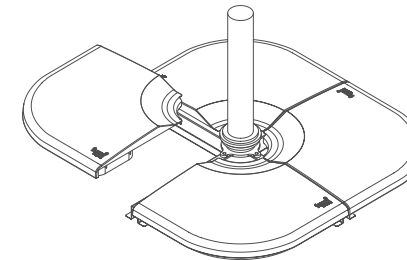

SUN UMBRELLA STAND

■ **PRECAST CONCRETE** POURED CONCRETE WITH POLYETHYLENE

- PP BALLAST - Polyethylene with concrete ballast
- _ 1/4 blocks in Polyethylene filled with concrete
 - _ Smooth semi matte finish
 - _ Felt caps for ground protection against scratching
 - _ To use with appropriate metal frame (metal frame not included)
 - _ Weight: **25Kg** or **35Kg**

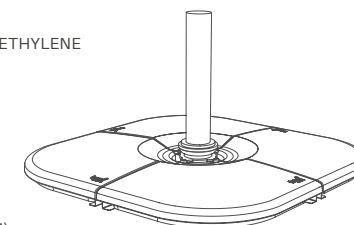

 Available in: 



5 606172 007127



sunny living 
tuozi 
by Movelar [®]

movelar® tuozi®
by Movelar

www.movelar.pt | www.tuozi.pt

Zona Industrial de Porto de Mós - Ruapincipal | Lote 17 - C
2480-407 Porto de Mós | Portugal

tel: +351 244 481 036 | fax: +351 244 482 003
movelar@movelar.pt



EU
PORTUGAL

